



TEPRO® K' in K'

Threaded plastic fasteners solutions
for plastic assemblies

Self-forming – self-tapping – adjustable –
reverse-locked

MeFaCo
INDUSTRIAL FASTENERS AND TOOLS

BÖLLHOFF

	Page
Introduction	2
Effectiveness and functionality of thread profiles	3
■ Böllhoff regular thread ■ Böllhoff round high thread	
Details about forming and tapping process	3
Manufacturing and selection of material	4
Versions of TEPRO® K' in K'	5
The screws	5
■ Operating sphere ■ Repeatably threaded connection ■ Mounting hole	
Inserts	6
■ Insert for ultrasonic welding ■ Mechanical components	
The systems	7
■ Body-bound rivet ■ Screw-in blind rivet	
The advantages	8
■ Screws ■ Inserts ■ Systems	
Description of applications	9
Examples for scopes of application	10
Our Service	10
Technical Information	11

Introduction

The assembly of plastic components using plastic screws and thread inserts is largely dependent on the mechanical requirements of the joint and whether a permanent or reversible fixing is required. The material compatibility of the component and the fastener also proves to be an essential influence.

Whilst DIN/ISO screws and nuts are the preferred method of de-mountable fastenings into metal fabrications, they are often incompatible with the assembly of plastic components. In the medium to long term service life, vibration and temperature variations and other external influences can result in failure of the thread connection.

The Böllhoff solution is the development of plastics in plastic (K' in K') screw thread technology with specially designed thread profiles. This enables integrated solutions for permanent and reversible fastenings which are self-locking, self-tapping, self-forming, adjustable and tolerance compensating. In addition, K' in K' screws and inserts have been designed specifically for use in thin gauge plastic sheet and plate, thereby increasing the scope of TEPRO® in the assembly of engineering plastics.



The various configurations in the K' in K' fastening systems consist of a base section, in the form of a sleeve, rivet, clip etc., which retains an aligned screw/insert at the point of assembly. Secure fastenings by means of screw-in blind rivet system and screw-in clip system, also exhibit the in-service benefits of dampening vibration and noise transfer.

Effectiveness and functionality of thread profiles

The precise thread geometry is fundamental to the effectiveness of K' in K' screw fastenings, as the fastener forms or taps a 'female' thread into cylindrical, close tolerance, pilot holes.

Thread profile:

Thread pitch, height of profile, pitch angle as well as the radius at the flank end and flank base, all influence the effectiveness of tapping or forming an internal thread into the parent material. The characteristics of the base material determines the type of K' in K' thread profile.

Thread forming is determined by either patented option;

Böllhoff K' in K' regular thread

or the

Böllhoff K' in K' round and high thread

The K' in K' regular thread is used for screwing into hard plastic materials, where the thread form is cut into a pilot hole.

The K' in K' round and high thread is preferable for applications where the base material has a higher degree of elasticity and high impact resistance.

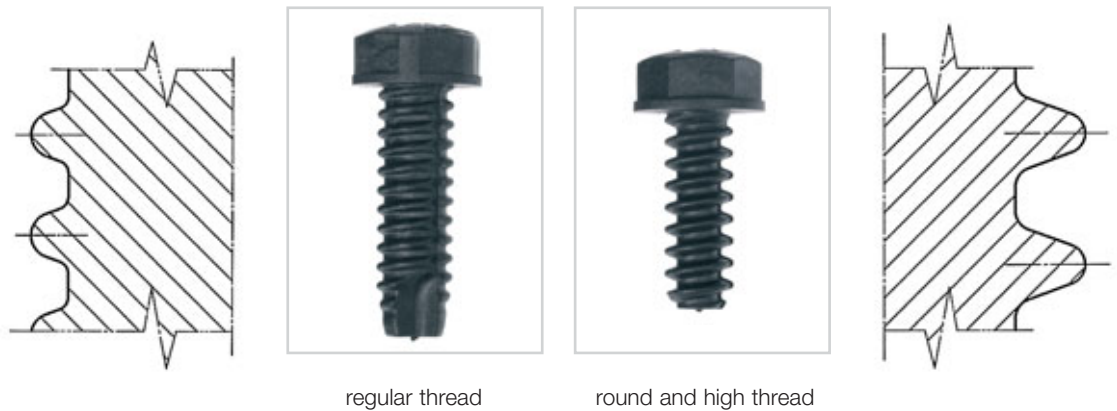

When which type of thread?



Details about forming and tapping process

A chip flute, running the length of the screw, enables effective tapping and forming without obstructing the thread flanks. The resulting cutting angle and adjacent clearance angle are at their most effective as the screw assembly is driven home under minimal torque.

The Böllhoff K' in K' regular thread corresponds to action of a screw tap and the Böllhoff K' in K' round and high thread to that of a thread former.

Torque and thread locking

The previously described geometry generates a low assembly torque during the process of turning the screw, whilst at the same time preventing any detachment under dynamic stress.

Unlike the conventional thread lock on metal screw connections, which can result in strain and surface pressure, the thread lock in the TEPRO® K' in K' screw fixing is a result of radial relaxation in the parent material to coalesce with the thread profile of the mating screw.

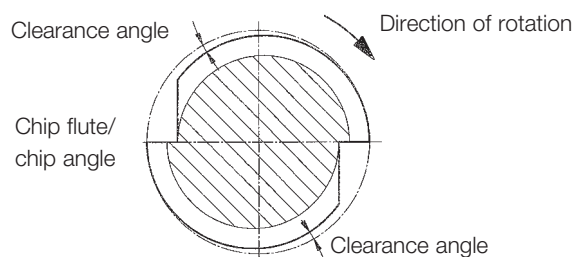

Thread connection with fine adjustment

The thread locking feature is particularly advantageous when adjusting the height along the axis. In each stepless position (irrespective of the direction of screw rotation) thread locking is maintained by subsequent relaxation of the host plastic, preventing any screw detachment under dynamic load.

Examples of applications:

- Headlight height adjustment
- Rear light fastening of backlights with adjustment of the gap size
- Block buffer for service cover flaps

Manufacturing and selection of material

The threaded fastener has to have material properties and characteristics which differ from those of the parent plastic. For this purpose selected thread materials are high performance engineering plastics featuring increased temperature resistance and a high degree of rigidity and strength. All of these properties must differ significantly from the host material, in order to maintain the required stability of profile and geometry, when tapping or forming the thread.

Preferred basic materials are:

- | | |
|-----------|--|
| ■ PA GF | high-quality glass filled Polyamide 66 |
| ■ PPA GF | Polyphthalamide glass filled |
| ■ PEI GF | Polyetherimide glass filled |
| ■ PPS GF | Polyphenylsulfide glass filled |
| ■ PEEK GF | Polyetheretherketone glass filled |

The K' in K' screws and inserts are formed from a.m. materials and manufactured according to the material requirements of the injection moulding process.

Total accuracy of temperature control within the injection moulding machine and the specially designed tooling is a precondition for achieving premium quality levels throughout the high volume production process.

Versions of **TEPRO® K' in K'**

As previously featured, the development principle of plastic (K' in K') thread fastenings provides for coordinated solutions for de-mountable and permanent fixings.

Here we differentiate three K' in K' options:

- **Screws**
- **Inserts and**
- **Systems.**

The screws

The following criteria are integral to final development of a self-forming, self-cutting fastener:

- Head shape and drive
- Support and power transmission
- Thread cutting geometry
- Thread chamfer



The operating sphere of K' in K' screw



Head design

Different styles are available, including

- DIN EN ISO 7045 slotted pan head screw
- DIN 34812 slotted pan head plastic screw
- DIN 34812 recessed plastic pan head screw

The multi-functional head design can be manufactured,

- With external hex drive and
- For the internal drive either a cross slot, socket or inner serration.

Support and transmission of force

The underside of the head provides a bearing area when the screw is driven into position. The transition to the thread plays an important role in enabling the necessary tapping and reforming work.

The dynamic load is absorbed in this zone. In order to spread this dynamic load in a larger area, a conical transition is designed.

The ribs beneath the head centres the K' in K' screw within the hole of component to be fastened. During the screwing process they support the fastening at a low cross-load.

Tapping geometry

This area forms and cuts the K' in K' thread into the plastic host component. Details q.v. "forming and tapping process".

Chamfer

A lead-in chamfer is formed at the base of the thread of a K' in K' screw. This facilitates centring within the pilot hole and relieves the pressure as it begins rotation to form a thread.

Repeatable threaded connection

Reversible thread connection of K' in K' screws enables repeated assembly and disassembly without deterioration of the thread, thread locking or overall performance.

Mounting hole

The diameter of any pilot hole has to be such that the central diameter of the K' in K' screw is clear of any deformation of the host material. To relieve the setting load, surface countersinking appropriate for the screw size and to a depth of one thread pitch is required. The countersinking aids with the location of the K' in K' screw and eases the introduction of the lead-in chamfer.

The outer diameter of the countersink is recommended as:

Surface diameter = size of K' in K' screw thread +> 4mm.

This dimensional recommendation relates to injection moulded components produced in optimum processing conditions.

Factors such as finish, size of chamfer, formation of joint lines in dome wall, as well as the relationship of dome design and load characteristics should be considered when determining the outer diameter.

Parts first produced from the mould should be subjected to load testing.

Inserts

In these TEPRO® K' in K' versions we differentiate between two types of insert.

TEPRO® K' in K' for ultrasonic welding and **TEPRO® K' in K' to mechanical turning in**

Insert for ultrasonic welding

On setting, the TEPRO® K' in K' plastic insert is surrounded by a heat field generated by USS (ultrasonic welding). USS is a technology developed for joining thermoplastic synthetics. The interface of insert and parent material is subject to friction as it absorbs the sonic vibration and the resultant heat plasticises the assembly. In a very short amount of time a positive and homogeneous joint is formed. The required energy is produced in the ultrasonic generator as AC voltage, converted into mechanical vibrations and introduced by the sonotrode. Using this plastic insert in glass filled materials produces even higher resistance threads. When recycling at the end of product life, there is no need for costly and time consuming material separation, as there is with metal inserts.

The insert is placed in a conical pilot hole within the parent material and welded ultrasonically. The insert is installed after the component has been moulded.

The ultrasonic welding procedure requires the use of identical material classification for both insert and host material. In this way a positive and homogeneous is assured.



Inserts



For the best results, the ultrasound vibration unit should be supplied by recognised manufacturers of ultrasonic welding equipment. Currently metric threads are available in M3, M4, M5, M6 and M8. American/British threads can be supplied.

Mechanical components

Plastic inserts can be screwed in by mechanical means to introduce a higher faster thread into plastic components. The external geometry of the thread is identical to the K' in K' screw (quod vide forming and tapping process). The precise diameter of the parallel-walled mounting hole is dependent on the material characteristics of insert and host component and differs accordingly.



Installation tool

During final installation of the insert it is first spun on to the spindle of the driver tool and then screwed into the component. The setting cycle stops when the installation tool makes contact with the parent carrier part.

Metric female threads in sizes of M3, M4, M5 and M10 can be manufactured. Currently available are sizes of M6 and M8. American/British threads can be manufactured.

The systems

Body-bound rivet



With this fastening system the rivet section forms a base for the screw.

Body-bound rivets are perfect fastening solutions for many types of application, principally where access is restricted to one side of the component. Varying thicknesses of material can be joined and the fastening is particularly effective in thin-walled blow moulded parts.

Function

The rivet element is pressed into a close tolerance hole within the principal component. A secondary component is then screwed into position by a K' in K' screw. As the self-tapping screw is driven into the spread nut form, the square section is forced to expand and four external wedges undercut the component to secure a tight fit.

Screw-in blind rivet



The screw-in blind rivet has been developed for fixing through round holes. To prevent rotation on setting, the surface of the rivet element has an integral flange to lip over the component edge. Other applications are made possible by an underside hexagonal form to the rivet body.

Function

The screw-in blind rivet is plugged into a hole in the bottom component. ① Lateral ribs prevent the rivet from falling out prior to setting. A mating K' in K' screw is located through a hole in the top component to engage with the internal bore or the rivet and form a thread. ②

Different riveting thicknesses are no problem for this fastening system, as the screw blind rivet clenches the underside of the bottom component, balancing tolerances along its axis as it does so. As the rivet section is drawn up under thread engagement, it is compressed at the neck and expands to form a blind side fastening. ③



The advantages

TEPRO® K' in K' screws

- A screw fastening with high reverse-lock
- Balancing of tolerances by adjustability
- No corrosion
- Chemical resistance
- Electromagnetic compatibility
- Minor conductivity of heat/isolator
- All-plastic fastening solution reduces component weight
- Capability of recycling – no expensive separating of component parts
- Any colour

TEPRO® K' in K' inserts for ultrasonic welding

- Tension free assembly, especially suitable for brittle materials
- Higher thread fastness in comparison to spindled thread components
- High pull-out strength
- Short times of welding (approx. 0.3 seconds)
- Very low noise development in welding compared to metal inserts
- Homogeneous connection between insert and component
- Capability of recycling – no expensive separating of component parts
- Minor conductivity of heat/isolator
- All-plastic fastening solution reduces component weight
- No corrosion
- Any colour

TEPRO® K' in K' inserts for mechanical turning in

- A screw fastening with high reverse-lock
- Balancing of tolerances by adjustability
- No corrosion
- Chemical resistance
- Electromagnetic compatibility
- Minor conductivity of heat/isolator
- All-plastic fastening solution reduces component weight
- Capability of recycling – no expensive separating of component parts
- Any colour

The advantages

TEPRO® K' in K' systems – screw-in blind rivet

- Fastening requires access from one side only
- No corrosion
- Electromagnetic compatibility
- All-plastic fastening solution reduces component weight
- Capability of recycling – no expensive separating of component parts
- Any colour

TEPRO® K' in K' systems – body-bound rivet

- Fastening requires access from one side only
- No corrosion
- Electromagnetic compatibility
- All-plastic fastening solution reduces component weight
- Capability of recycling – no expensive separating of component parts
- Thin-walled blow moulding parts
- Any colour

Description of applications

Threaded connection assembly carrier “Touareg” (VW)



Self-tapping K' in K' screws have been used effectively to fasten a two-part assembly within the interior trim of the Touareg.

Here the K' in K' plastic screw forms its own mating thread within a cylindrical pilot hole set in the base component. As the host material relaxes into the longitudinal slot of the screw, a reverse-lock is achieved. Clamp ribs on the underside of the screw head guarantee an automatic centring of the assembled parts.

Concealed window stop “SMART” (Daimler)

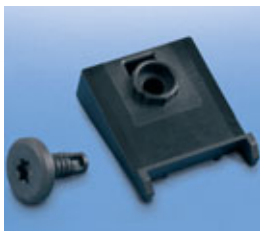

Development of an all-plastic window stop has achieved noise insulation within the side door window plates.

The self-grooving K' in K' screw secures the stop, which in turn adjusts to rough tolerance holes in the glass by means of ribs. The stop is a press fit and a float-free fastening is achieved by the screw.

Fastening the air outlet cover



An air outlet cover made from HD-PE is fastened into a thin walled section by means of a K in K' screw and body-bound rivet.

With access available on one side only, the cover is applied to the spread nut and a size 7 L12 K' in K' screw is located and driven home to cut an internal thread. As the screw enters, it splays out the plastic rivet body and undercuts the material of the host component to achieve a tight fit.

Examples for scopes of application

Böllhoff K' in K' screw fastening solutions have been applied in different spheres.



- Automotive industry:
Fastening of instrument panel, threaded connection assembly carrier, fastening of headlights...



- Commercial vehicles (lorries, tractors...):
Tank for water equalizing



- Electricity, electronics:
safety switch cabinets

- Office furniture:
Chairs, desks



- HVAC

- Landscape technology, lawn chairs:
Shield fasteners



Our Service

As a specialist service provider, we welcome enquiries for K' in K' threaded fasteners and recommend solutions dependent on the parent material.

The conditions for the most effective threaded fastenings in plastic are many and varied.

These include:

- Optimal length of screw insertion
- Required speed of insertion
- Tightening torque, overwinding torque, screw-in as well as loosening torque
- Threaded fastening in repeated assembly

The design and production criteria are assessed by assembling samples of original components. If these are not available at a development stage, test samples are prepared out of selected materials and used for evaluation.

Technical information – dimensions

TEPRO® K' in K' – screw-set fastening elements

 K' in K' bottom part
screw-in blind rivet

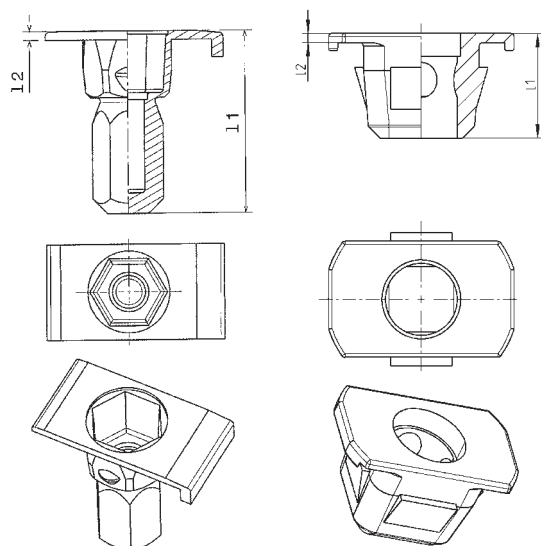
 K' in K' bottom part
spread nut

Part no.	Description	Screw size/L	Total length L1 mm	Collar height L2 mm	Hole mm	Thickness of carrier mm	Material	Colour	Comment
0400 132 8002	K' in K' bottom part blind rivet for K' in K' screw 0403 730 6418	size 6 L 18	26.8	1.3	D 13	0.8 – 3	PA 66-6	black	*
0499 046 0026	K' in K' bottom part spread nut for K' in K' screw 0402 790 7001...	size 7 L 12	9	0.8	10 x 10	1.5	PA 66-6	black	*

* On request. Please contact our specialist department.

Technical information – mechanical properties

TEPRO® K' in K' systems – screw-in blind rivet

Material of carrier	Thickness of carrier mm	Screw-in torque M_E [Nm]	Tightening torque M_A [Nm]	Loosening torque M_L [Nm]	Axial pull-out force F [N]
steel	0.8 – 3	0.3	1.2 – 1.6	approx. 1	approx. 400

Rotational speed of screw insertion 350 min⁻¹

These indicative values have to be related to each specific application.

TEPRO® K' in K' – screws

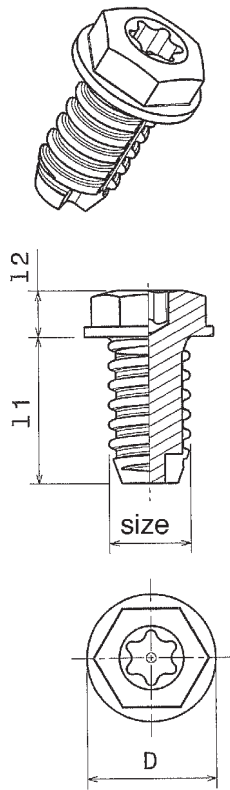

Part no.	Description	Böllhoff K' in K' thread	Dimensions of thread	
			Thread size	Thread length L1
0406 730 6012	K' in K' screw size 6 L 12	regular thread	6	12
0403 710 6018	K' in K' screw size 6 L18	regular thread	6	18
0403 720 6018	K' in K' screw size 6 L 18	regular thread	6	18
0403 730 6018	K' in K' screw size 6 L 18	regular thread	6	18
0412 730 6020	K' in K' screw size 6 L 20	regular thread	6	20
0402 730 6025	K' in K' screw size 6 L 25	regular thread	6	25
0403 900 6001	K' in K' screw size 6 L 18	regular thread	6	18
0402 730 7012	K' in K' screw size 7 L 12	regular thread	7	12
0403 730 7014	K' in K' screw size 7 L 14	regular thread	7	14
0403 730 7022	K' in K' screw size 7 L 22	regular thread	7	22
0402 790 7001	K' in K' screw size 7 L 12	regular thread	7	12
0402 790 7002	K' in K' screw size 7 L 12	regular thread	7	12
0402 790 7003	K' in K' screw size 7 L 12	regular thread	7	12
0402 790 7004	K' in K' screw size 7 L 12	regular thread	7	12
0402 790 7005	K' in K' screw size 7 L 12	regular thread	7	12
0402 730 8025	K' in K' screw size 8 L 25	regular thread	8	25
0403 730 6418	K' in K' screw size 6 L 18	round high thread	6	18
0403 930 6003	K' in K' screw size 6 L 12	round high thread	6	12

TEPRO® K' in K' – special parts

Part no.	Description	Böllhoff K' in K' thread	Dimensions of thread	
			Thread size	Thread length L1
0419 007 5201	Setting screw	regular thread	5.2	12
0419 011 0601	Buffer	regular thread	6	19.5
0419 011 0602	Buffer	regular thread	6	19.5
0419 013 0601	K' in K' screw size 6 L 11.5	regular thread	6	11.5
0419 016 0701	Stud	regular thread	7	11
0419 014 0701	K' in K' screw size 7 L 28 (22.8)	round high thread	7	22.8

* On request. Please contact our specialist department.

** Material depends on carrier. Alternative materials quo vide page 4.

Type	Head version		Internal drive		External drive (width across flats)	Material**	Colour	Comment
	Outer head-Ø D mm	Head height l2 mm	Socket	Cross recess				
Pan hexagon	12	5	DIN EN ISO 10664-30		10	PPA GF	black	
Pan hexagon	12	6		Form Z size 3	10	PPA GF	headlight grey almost RAL 7034	
Pan hexagon	12	6		Form Z size 3	10	PPA GF	white	series tool
Pan hexagon	12	6		Form Z size 3	10	PPA GF	black	
Pan head	15	5	DIN EN ISO 10664-30			PPA GF	black	
Pan head	16	6		Form Z size 3		PPA GF	black	*
Pan hexagon	12	6		Form Z size 3		PEEK GF	natural	*
Pan head	12	4.6		Form Z size 3		PPA GF	black	
Pan hexagon	12	6		Form Z size 3	11	PPA GF	black	*
Pan hexagon	12	6		Form Z size 3	11	PPA GF	black	*
Pan head	12	4.6		Form Z size 3		PPA GF	green	*
Pan head	12	4.6		Form Z size 3		PPA GF	yellow	*
Pan head	12	4.6		Form Z size 3		PPA GF	light platinum	*
Pan head	12	4.6		Form Z size 3		PPA GF	blue	*
Pan head	12	4.6		Form Z size 3		PPA GF	torrone	*
Pan head	15	6		Form Z size 4		PPA GF	black	
Pan hexagon	12	6		Form Z size 3	10	PPA GF	black	*
Pan hexagon	12	6		Form Z size 3	10	PPA GF	black	*

Type	Head version		Internal drive		External drive (width across flats)	Material**	Colour	Comment
	Outer head-Ø D mm	Head height l2 mm	Socket	Cross recess				
Special head	14	9	T20 with lock nut		10	PPA GF/ EPDM-X+PP 35 Shore A	black	*
Pin head	7.8	10.5	DIN EN ISO 10664-15		4	PPA GF/ EPDM-X+PP 73 Shore A	black	* Rear external drive
Pin head	7.8	10.5	DIN EN ISO 10664-15		4	PPA GF/ EPDM-X+PP 64 Shore A	black	* Rear external drive
Flathead	15	6	DIN EN ISO 10664-30			PPA GF	black	*
Pin head	10	11	VW 010-43 N5			PPA GF	black	*
Special head	–	18.2			15/5	PPA GF	black	*

TEPRO® K' in K' – inserts for ultrasonic welding

K' in K' Type 163

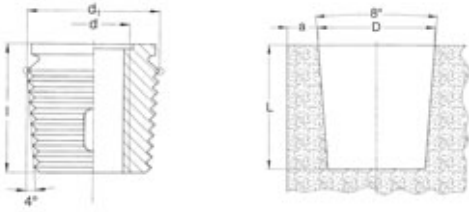

Part no.	Description	Material**	Colour	Dimension female thread d	Collar diameter d1 mm	Total length l mm	Mounting hole D + 0,1 mm	Minimum bore depth L mm	Thickness of carrier a min. mm	Comment
1631 303 0075	Type 163	PA GF (Blend)	black	M 3	5.8	7.5	5.7	8.5	2.3	*
1631 304 0009	Type 163	PA GF (Blend)	black	M 4	7.0	9.0	6.9	10.0	2.5	
1639 004 0002	Type 163	PEI	natural	M 4	7.0	9.0	6.9	10.0	2.5	
1639 304 0001	Type 163	PSU	natural	M 4	7.0	9.0	6.9	10.0	2.5	*
1631 305 0010	Type 163	PA GF (Blend)	black	M 5	8.6	10.0	8.5	11.0	2.8	
1631 306 0012	Type 163	PA GF (Blend)	black	M 6	11.0	12.0	10.9	13.0	3.0	
1631 308 0015	Type 163	PA GF (Blend)	black	M 8	14.0	15.0	13.9	16.0	4.0	

* On request. Please contact our specialist department.

** Selection of material depends on carrier.

TEPRO® K' in K' – inserts for ultrasonic welding

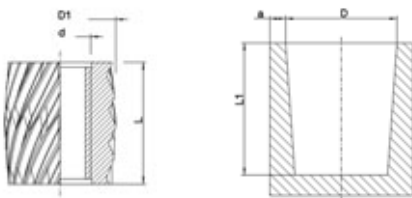

Part no.	Description	Material**	Dimension female thread d	D1 mm	Total length L mm	Mounting hole D + 0,1 mm	Minimum bore depth L1 mm	Thickness of carrier a min. mm	Comment
0404 0030 XXX	Insert for thermal installation	PPA GF	M 3	5.8	7.5	5.7	8.5	2.3	*
0404 0040 XXX	Insert for thermal installation	PPA GF	M 4	7.0	9.0	6.9	10.0	2.5	*
0404 0050 XXX	Insert for thermal installation	PPA GF	M 5	8.6	10.0	11.0	11.0	2.8	*
0404 0060 XXX	Insert for thermal installation	PPA GF	M 6	11.0	12.0	10.9	13.0	3.0	*
0404 0080 XXX	Insert for thermal installation	PPA GF	M 8	14.0	15.0	16.0	16.0	4.0	*

* On request. Please contact our specialist department.

** Selection of material depends on carrier.

TEPRO® K' in K' – inserts for screw driving installation

K' in K' Type 173

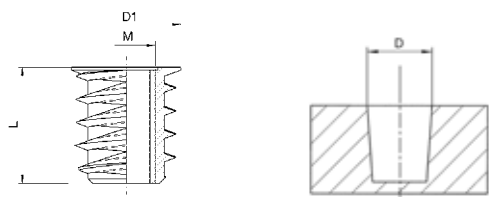

Part no.	Description	Material**	Colour	Dimension female thread M	Collar diameter D1 mm	Total length L mm	Mounting hole D + 0,1 mm	Comment
1731 303 0006	Type 173	PA GF	black	M 3	6.8	6.0	4.7	*
1731 304 0008	Type 173	PA GF	black	M 4	7.8	8.0	5.5	*
1731 305 0010	Type 173	PA GF	black	M 5	9.4	10.0	6.8	*
1731 306 0014	Type 173	PA GF	black	M 6	11.2	14.0	7.6/8.5	*
1731 308 0015	Type 173	PA GF	black	M 8	13.2	15.0	10.3/10.5	*
1731 310 0018	Type 173	PA GF	black	M 10	15.2	18.0	11.8/12.5	*

* On request. Please contact our specialist department.

** Selection of material depends on carrier.

TEPRO® K' in K' – inserts for screw driving installation

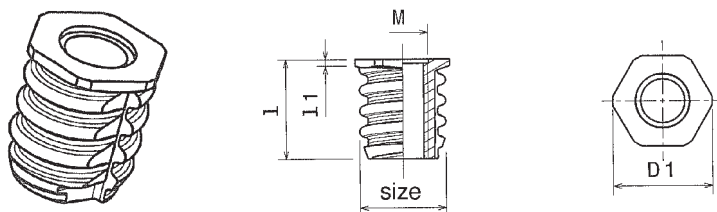

Part no.	Description	Böllhoff K' in K' thread	Thread size	Dimension female thread M	Total length l mm	Collar diameter D1 mm	Collar height mm I1	Comment
0402 003 XXXX	Insert K' in K' M 3 x 8	regular thread	6	M 3	8.0	6.8	0.6	*
0402 004 XXXX	Insert K' in K' M 4 x 9	regular thread	7	M 4	9.0	7.9	0.6	*
0402 005 XXXX	Insert K' in K' M 5 x 10	regular thread	8	M 5	10.0	9.0	0.6	*
0402 006 0003	Insert K' in K' M6 x 12	regular thread	10	M 6	12.0	11.3	0.8	*
0402 008 0004	Insert K' in K' M 8 x 14	regular thread	12	M 8	14.0	13.5	0.8	*

* On request. Please contact our specialist department.

Selection of material depends on carrier.

Böllhoff International with companies in:

Argentina
Austria
Brazil
Canada
China
Czech Republic
France
Germany
Hungary
India
Italy
Japan
Korea
Mexico
Poland
Romania
Russia
Slovakia
Spain
Switzerland
Turkey
United Kingdom
USA

Apart from these 23 countries, Böllhoff supports its international customers in other important industrial markets in close partnership with agents and dealers.