



RIVQUICK®

Power tools



BÖLLHOFF

RIVQUICK® P series - Hydraulic/pneumatic blind setting tools**A light and robust range of tools**

For small quantities or large productions runs



Complete with mandrel container equipped with a vacuum system and security valve to switch off air supply

**RIVQUICK® B series - Battery operated setting tools****A well-balanced portable tool**

An electric range for high assembly rate



Facilitate access to cramped environment



RIVQUICK® P series - Multi-purpose riveting capabilities

RIVQUICK® P1000



 Alu Zinc plated Stainless steel	∅						
	2,4	3,0	3,2	4,0	5,0	6,0	6,4
Alu	<input type="checkbox"/>	<input type="checkbox"/>	<input type="checkbox"/>	<input type="checkbox"/>	<input type="checkbox"/>		
Zinc plated	<input type="checkbox"/>	<input type="checkbox"/>	<input type="checkbox"/>	<input type="checkbox"/>	<input type="checkbox"/>		
Stainless steel	<input type="checkbox"/>	<input type="checkbox"/>	<input type="checkbox"/>	<input type="checkbox"/>	<input type="checkbox"/>		

 **226 030** 01000 - delivered with 3,2 / 4,0 / 5,0 nose pieces for each type.

RIVQUICK® P2000



 Alu Zinc plated Stainless steel	∅						
	2,4	3,0	3,2	4,0	5,0	6,0	6,4
Alu				<input type="checkbox"/>	<input type="checkbox"/>	<input type="checkbox"/>	<input type="checkbox"/>
Zinc plated				<input type="checkbox"/>	<input type="checkbox"/>	<input type="checkbox"/>	<input type="checkbox"/>
Stainless steel				<input type="checkbox"/>	<input type="checkbox"/>	<input type="checkbox"/>	<input type="checkbox"/>

 **226 031** 01000 - delivered with 4,0 / 5,0 / 6,0 nose pieces for each type.

RIVQUICK® P3000



 Alu Zinc plated Stainless steel	∅						
	2,4	3,0	3,2	4,0	5,0	6,0	6,4
Alu					<input type="checkbox"/>	<input type="checkbox"/>	<input type="checkbox"/>
Zinc plated					<input type="checkbox"/>	<input type="checkbox"/>	<input type="checkbox"/>
Stainless steel					<input type="checkbox"/>	<input type="checkbox"/>	<input type="checkbox"/>

 **226 032** 01000 - delivered with 5,0 / 6,0 / 6,4 nose pieces for each type.

RIVQUICK® B series - Multi-purpose riveting capabilities

RIVQUICK® B2000





 Alu Zinc plated Stainless steel	∅						
	2,4	3,0	3,2	4,0	5,0	6,0	6,4
Alu	<input type="checkbox"/>	<input type="checkbox"/>	<input type="checkbox"/>	<input type="checkbox"/>	<input type="checkbox"/>		
Zinc plated	<input type="checkbox"/>	<input type="checkbox"/>	<input type="checkbox"/>	<input type="checkbox"/>	<input type="checkbox"/>		
Stainless steel	<input type="checkbox"/>	<input type="checkbox"/>	<input type="checkbox"/>	<input type="checkbox"/>	<input type="checkbox"/>		

 **226 040** 01000 - delivered with 2 batteries (1,4 Ah) and the noses 2,4 / 3,2 / 4,0 / 5,0

RIVQUICK® B3000



 Alu Zinc plated Stainless steel	∅						
	2,4	3,0	3,2	4,0	5,0	6,0	6,4
Alu				<input type="checkbox"/>	<input type="checkbox"/>	<input type="checkbox"/>	<input type="checkbox"/>
Zinc plated				<input type="checkbox"/>	<input type="checkbox"/>	<input type="checkbox"/>	<input type="checkbox"/>
Stainless steel				<input type="checkbox"/>	<input type="checkbox"/>	<input type="checkbox"/>	<input type="checkbox"/>

 **226 041** 01000 - delivered with 2 batteries (2,8 Ah) and the noses 4,0 / 5,0 / 6,0 / 6,4 / 4,8 Varibolt / 6,4 Varibolt

RIVQUICK® P series - Technical characteristics

- Benefits:**
- Light
 - Ergonomic
 - Security
 - A full range of accessories

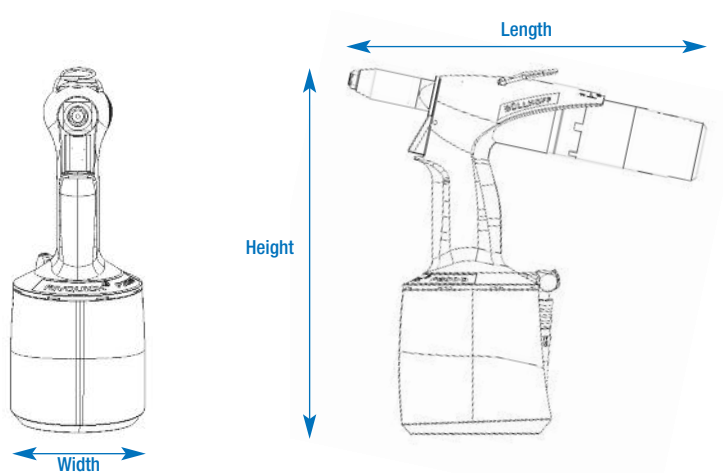

	RIVQUICK® P1000	RIVQUICK® P2000	RIVQUICK® P3000
Weight	1 250 g	1 650 g	1 800 g
L x H x W	268 x 264 x 101 mm	272 x 275 x 120 mm	272 x 277 x 130 mm
Setting force	7 300 N	12 500 N	16 000 N
Tool stroke	17 mm	21 mm	25 mm
Air pressure	5 - 7 bars	5 - 7 bars	5 - 7 bars
Air consumption	1,5 l/cycle	2,5 l/cycle	3,0 l/cycle
Sound level	< 70 dB (A)	< 70 dB (A)	inf 70 dB (A)
Cycle time	35 to 80 pcs/min	25 to 50 pcs/min	25 to 40 pcs/min

RIVQUICK® B series - Technical characteristics

- Benefits:**
- Robust
 - Convenient battery operation
 - Ease of use
 - Performance

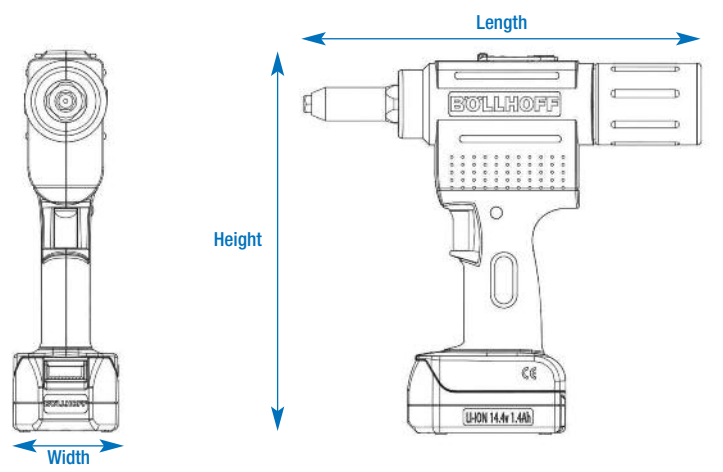

	RIVQUICK® B2000	RIVQUICK® B3000
Weight	2 000 g	2 200 g
L x H x W	285 x 273 x 75 mm	285 x 283 x 75 mm
Setting force	10 000 N	18 000 N
Tool stroke	20 mm	27 mm
Battery	Li-Ion-14,4V-1,4Ah	Li-Ion-14,4V-2,8Ah
Sound level	< 70 dB (A)	< 70 dB (A)
Cycles number/battery	550*	770*
Charging time	< 60 min	< 60 min
Cycle time	27 to 30 pcs/min	20 to 25 pcs/min

* Setting of alu/steel rivets diameter 4,0

RIVQUICK® P series - Spare parts / Tooling

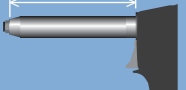

		RIVQUICK® P1000	RIVQUICK® P2000	RIVQUICK® P3000
Nose piece 	Ø 2,4	226 030 24001		
	Ø 3,2	226 030 32001		
	Ø 4,0	226 030 40001		
	Ø 5,0	226 030 50001		
	Ø 6,0		226 031 60001	
	Ø 6,4		226 031 64001	
	Ø 4,8 Varibolt		226 031 48001	
	Ø 6,4 Varibolt			226 032 64001
	1 set of jaws 3 pieces	Ø 2,4 → Ø 6,4	226 030 00002	

Accessories

		RIVQUICK® P1000	RIVQUICK® P2000	RIVQUICK® P3000
Extended nose piece 	XX mm	226 030 00110	226 031 00110	226 032 00110
	XX = 110 mm	226 030 00120	226 031 00120	226 032 00120
	XX = 160 mm	226 030 00130	226 031 00130	226 032 00130
	XX = 210 mm			

Length of a standard nose piece = 64 mm

RIVQUICK® B series - Spare parts / Tooling

		RIVQUICK® B2000	RIVQUICK® B3000
Nose piece 	Ø 2,4	226 040 24001	
	Ø 3,2	226 040 32001	
	Ø 4,0	226 040 40001	
	Ø 5,0	226 040 50001	
	Ø 6,0		226 041 60001
	Ø 6,4		226 041 64001
	Ø 4,8 Varibolt		226 041 48002
	Ø 6,4 Varibolt		226 041 64003
1 set of jaws 3 pieces	Ø 2,4 → Ø 6,0	226 040 00004	
	Ø 6,4		226 041 00004
Battery 	Li-Ion-14,4V-1,4Ah	226 040 00018	
	Li-Ion-14,4V-2,8Ah	226 040 00019	
Battery charger 	100-240V~50-60Hz-1A	226 040 00020	

Böllhoff International with companies in:

Argentina
Austria
Brazil
Canada
China
Czech Republic
France
Germany
Hungary
India
Italy
Japan
Korea
Mexico
Poland
Romania
Russia
Slovakia
Spain
Switzerland
Turkey
United Kingdom
USA

Apart from these 23 countries, Böllhoff supports its international customers in other important industrial markets in close partnership with agents and dealers.

Subject to technical change.
Reprinting, even in extract form, only permitted with express consent.
Observe protective note according to ISO 16016.

MeFaCo Intl. bvba
Industrieweg 2, B-9200 Dendermonde Belgium
Tel.: +32 (0)52 203923 Fax : +32 (0)52 219524
Web : <http://www.mefaco-intl.com>
E-mail : info@mefaco-intl.com

